

Feuchtigkeitsmessgeräte
Moisture Meter
Humidimètre



DM4A Operating Instructions



Moisture Meter type DM4A for
wood, building materials, paper and cardboard

Moisture Meter Type DM4A

Description:

The electronic moisture meter DM4A is used to determine in a matter of seconds the moisture in materials. The average moisture, down to a depth of approx. 3 cm is measured.

materials: wood, building materials, paper and cardboard

Measuring Ranges:

wood: 0,0 - 99,9 % H₂O

building materials: 0,0 - 20,0 % H₂O

paper and cardboard: 0,0 - 50,0 % H₂O

material temperature range: 5 - 40°C

working temperature range: 5 - 40°C

storage temperature range: -20 - 70°C

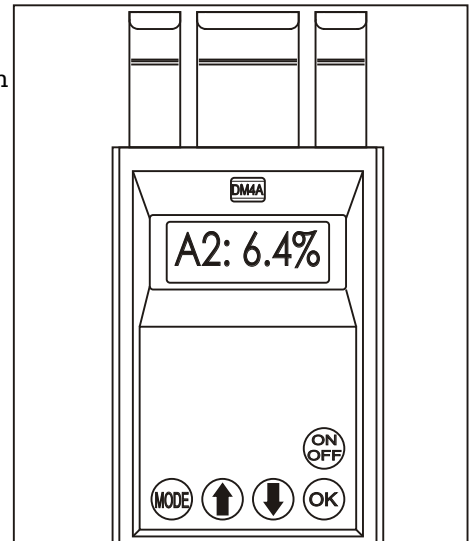

Method of Operation:

The measuring electrodes ① of the meter are pushed during the measuring process on the material to be measured, so that a high frequency electrical field is able to pass through the material. A micro processor receives the measured signals and determines from the measured value the percentage water content taking into account the material setting group.

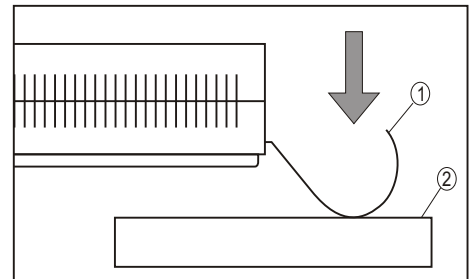

Measuring Principle:

The meter works in accordance with the principle of an opened plate capacitor. The capacity of the capacitor depends on the material- (dielectric)-constant of the material in between the plates. Compared with air ($\epsilon_r = 1$), for example water has a very high dielectric-constant ($\epsilon_r = 80$). The water content of a wet material can therefore be determined by determining the dielectric constant of this material.

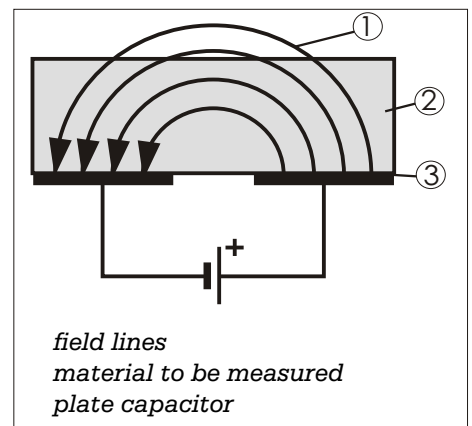

Safety Tips:

- follow the operating instructions
- only use the meter as directed (see page 1)
- keep the meter away from live and current electrical parts
- avoid impacts
- protect the meter from heat
- keep the meter dry and try to prevent dirt from entering the case
- protect the meter from electrostatic discharge.
- the meter must be repaired or serviced only by qualified specialists

Damages caused by failure to follow the above Safety Tips are not covered by the warranty !



Moisture Meter Type DM4A

Measurement Preparation:

- **material thicknesses < 5 cm** : use suitable bases (for example: polystyrene or foamed plastic plates - no metal!) or even better: hold the material to be measured into the air
- **thin materials (< 2 cm)** : measure on a pile (thickness at least 2 cm, avoid air gaps between the individual layers)
- look for an **even, smooth surface** (minimum size for the measurement 10 x 10 cm)
- **minimum distance of the electrodes** from the edge of the surface: 1 cm

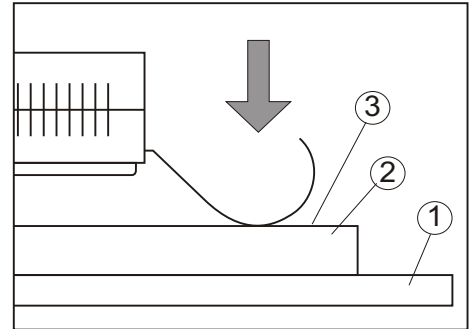

Turn on the Meter:

- Push ON/OFF-button, the display shows the adjusted material group. Hold the instrument into the air for automatic zero point measurement and correction, if the zero point is not in the valid range, the display shows "NP-ERROR".
- release the ON/OFF-button, the display shows e.g. "A1: 0,00%", the instrument is now ready for use (the first two characters always shows the adjusted material group and number).

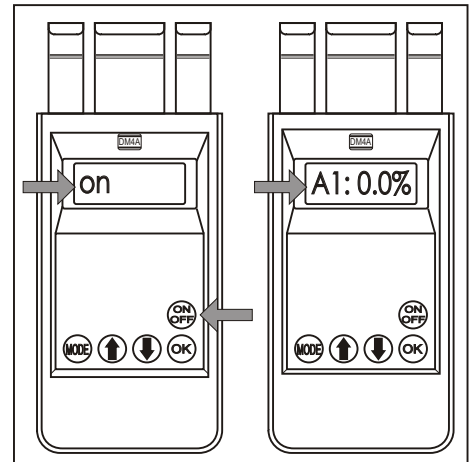

Parameter Settings:

With code numbers parameter settings can be changed. Press both arrow buttons, the display shows "code:00", adjust the required code with the arrow buttons and confirm it with OK. The following parameters are changeable:

- code 11: storage adjustments (OFF, ON single, ON auto)
 - ON single:** single values will be stored by pressing the OK-button
 - ON auto:** All values > 0,0% will be stored automatically after pressing OK until the storage is filled up or until the OK-button is pressed again.
- code 12: number of measurements per second (mps)
range 0 - 10
- code 13: number of measurements until automatic switching off (loops)
range 0 - 999, loops = 0: no automatic switching off
- code 14: delete storage, through changing the material setting the storage will be deleted too.
- code 21: attenuation (damp), range 0 - 99
- code 22: automatic maximum value measuring (automax)
no automatic maximum measurement (float)

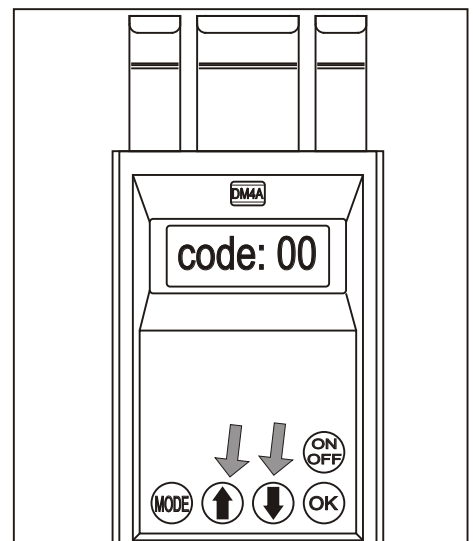

Material Groups:

For using the required stored material group the corresponding code has to be selected (the sign is always displayed as the first character):

- code 30: sign S, customer specific curves
- code 31: sign H, wood (HD5)
- code 32: sign P, paper and cardboard (PD2)
- code 33: sign A, wood (BD2)
- code 34: sign B, building materials (BD2)

the selected group is always displayed during the measurements

Additional adjustments can be made with the optional PC-Software **DMI-Controller**

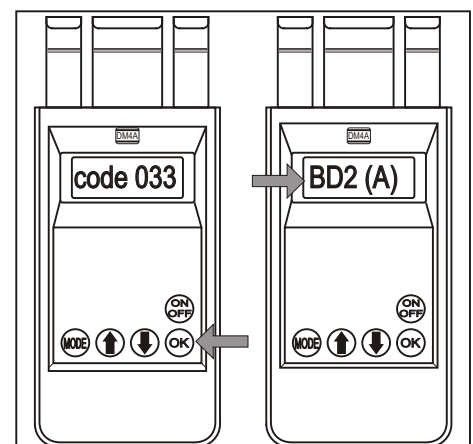

Moisture Meter Type DM4A

Setting of Material number:

With the MODE-button the required material number can be selected. The display shows A1 if the material setting A1 was selected before. The material number can be changed with the arrow buttons. At the material groups A, B, C and D it's possible to switch between wood to building materials by pushing the MODE button. The change has to be confirmed with OK. The material number is shown as the second character in the display.

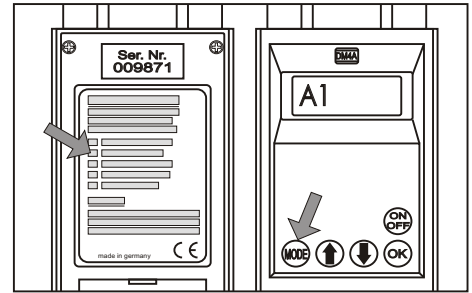

Material Moisture Measuring:

- press the meter on the material, if "automax" is activated, the maximum value is taken automatically and if the meter is pushed again with the sensors to a material, a new measurement starts.
- read off the moisture.

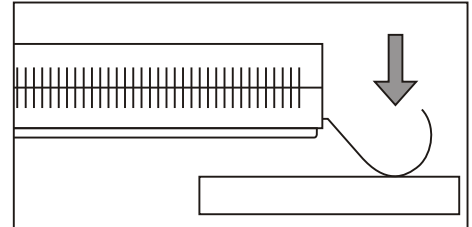

Turn off the Meter:

- push "ON/OFF" button until the display shows "OFF"
- release "ON/OFF" button, the meter is turned off

After an adjustable number of measurements (loops) the instrument switches off automatically. If loops is adjusted to 0, the automatic turning off is deactivated. In this case the instrument has to be turned off by pushing the ON/OFF-button.

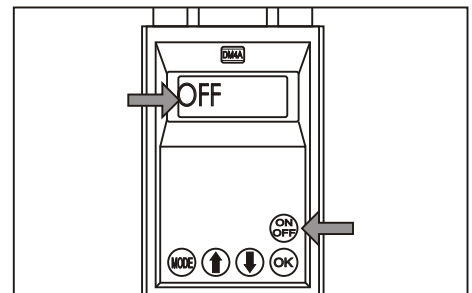

Storing of Moisture Values:

If the storage is activated, by pushing the OK-button up to 100 values can be stored. If the storage parameter is set to "on single" always one value is stored, if the parameter is set to "on auto" every value > 0,0% is stored automatically until the storage is filled up or the OK button is pressed again. The number of measurements per second (mps) can be adjusted between 1 and 10. The storage procedure will be signed with an "S" at the end of the display instead of the %-sign.

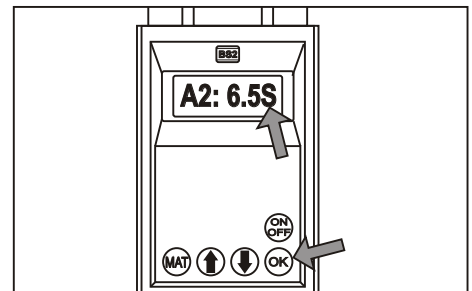

The stored values will be kept also during switching off position.

Restorage of the Stored Values:

By pushing the "OK" and the " " button, the stored values can be restored with the arrow buttons. The first two signs always shows the storage place:

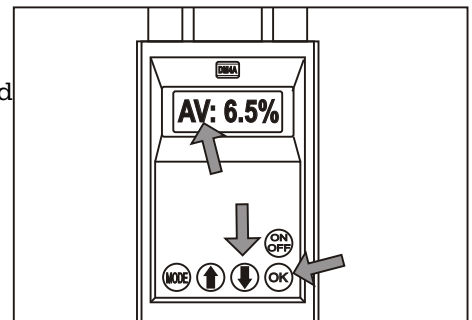

MI:	8.7%	highest value
AV:	4.5%	average value
MA:	9.6%	lowest value
01:	5,2%	1. stored value

·
·
·

100: 7,3% 100. stored value

With our optional interface cable and software **DMI-Controller** the stored values can be transferred to a PC for storing them into a file or showing them on a graph.

Cancellation of the Stored Values:

After changing the material adjustment or with code 14, the stored values will be cancelled, which is shown as "DELETE" on the display.

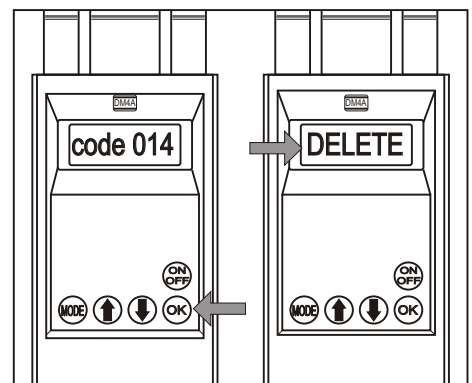

Moisture Meter Type DM4A

Checking Measuring Quality:

We recommend carrying out regular periodical controlling check measurements, as different local circumstances might need different material adjustments. (recommendation: controlling measurements by oven drying method ISO 3130-1975 for wood or DIN ISO 287 for paper)

Screed Moisture Measuring:

For accurate determination of moisture in different kind of screed we recommend to use special calibrated instruments. For further information, please contact:

DNS-Denzel Natursteinschutz GmbH • Am Wasserturm 5 • 73104 Börtlingen; Germany

Tel: +49 (0) 7161 959 336 • Fax: +49 (0) 7161 959 337 • info@dns-denzel.de • www.dns-denzel.de

The DM4A can be used for measuring moisture differences:

1. the measurements are non damaging
2. the measurements are very quickly done
3. if the measured values are too high, time sensitive exact measurements e.g. the oven drying method, are superfluous.

Even in one room great differences of the moisture in the flooring are possible. Therefore non-damaging measurements are necessary to find out the critical places for an exact time sensitive measurement as e.g. the oven drying method.

The number of such damaging measurements are then minimised.

The result of our capacitive moisture meter depends on differences in density, mixtures and surface roughness. It depends also from the moisture profile. The influence to the moisture gets smaller for higher depth. The measuring result is an average moisture value.

With our moisture meter it is possible to observe the drying process. If at the same place after several days the moisture result does not change, the moisture is in balance with the air humidity. In this case also at high moisture readings an exact comparing measurement e.g. with the oven drying method is recommended.

Oven Drying Method:

The oven drying method is the most accurate way to measure the material moisture in wood (ISO 3130-1975), building materials and paper (DIN ISO 287).

We recommend this for testing and calibrating of all electronic moisture meters.

Short description:

1. For measuring the weights, we recommend a balance with an measuring range of 200g and an accuracy of 0,01g
2. For drying you need an oven with adjustable temperatures of 40, 100 and 104°C
3. Take a probe from wood with a sharp saw, avoid edge parts. For building materials take a probe with a sharp chisel to a depth of at least 3cm. the probe should be at least 20g
4. It is very important to take the weight of the first probe immediately, as air humidity may change the moisture content. Name of the first weight as wet weight (WW)
5. The probe must be dried in the oven until the weight is constant.
The maximum drying temperatures:
for wood: 104 °C (ISO 3130-1975)
for paper 100°C (DIN ISO 287)
for e.g. concrete flooring: 40 °C
for anhydride flooring: 40°C
7. The name of the dry weight is DW.
8. The moisture content is calculated with the formulas:

$$\text{wood moisture (ISO 3130-1975):}$$
$$\text{MOISTURE} = \frac{(\text{WW} - \text{DW})}{\text{DW}} * 100 \%$$

$$\text{building materials and paper:}$$
$$\text{MOISTURE} = \frac{(\text{WW} - \text{DW})}{\text{WW}} * 100 \%$$

Moisture Meter Type DM4A

Customer Specific Linearisation Curves:

The meter can be programmed for up to 10 customer specific linearisation curves. Each curve is programmable with up to 8 points. The curves will stay in the memory during replacement of the battery. For changing the linearisation curves, the software **DMI-Controller** is recommended. The customer specific curves can be selected with code 30. The material group is named "spec. curves".

Basic Calibration:

The moisture meter can be tested and calibrated with the test modules PE05 and PE30.

For calibration use code no. 97, in the display the text "NPW UF" is shown shortly

1. test of zero point: the display shows e.g. "N16 15", then the zero point is 16 and the actual measuring value is 15. For testing hold the instrument free into the air, wait till the two values are equal. The zero point must be < 100! The optimum value is between 10 and 90. Press "OK" for the next calibration step.

2. first measurement on PE30
the display shows shortly "CAL1HIGH", then e.g. "176 0189", the first value is the calibration factor, the second is the measuring value. Change with the arrow buttons till the measuring value is 200 ± 2 and press "OK"

3. second measurement on PE30:
the display shows shortly "CAL1LOW", the rated value is 200 ± 4

4. first measurement on PE05:
the display shows shortly "CAL2HIGH", the rated value is 500 ± 5

5. first measurement on PE05:
the display shows shortly "CAL2LOW", the rated value is 500 ± 10

The calibration factors can be changed in the range between 150 and 255 by pressing the "OK"-button in the 5th step, the changed calibration factors will be stored. The instrument is then ready calibrated.

If the calibration is not possible, please send the instrument for repair.

Alternatively the calibration can be done with the PC and the software DMI-Controller. Important: through the connection cable the measurement value can be influenced a little!

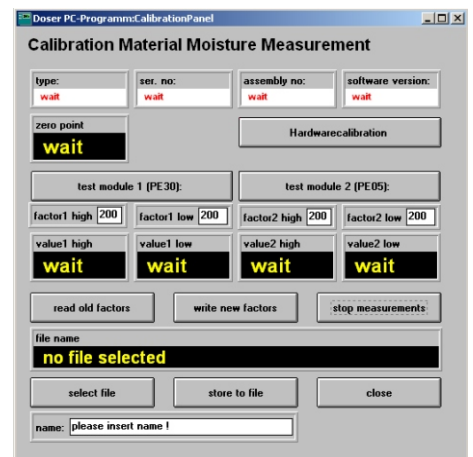
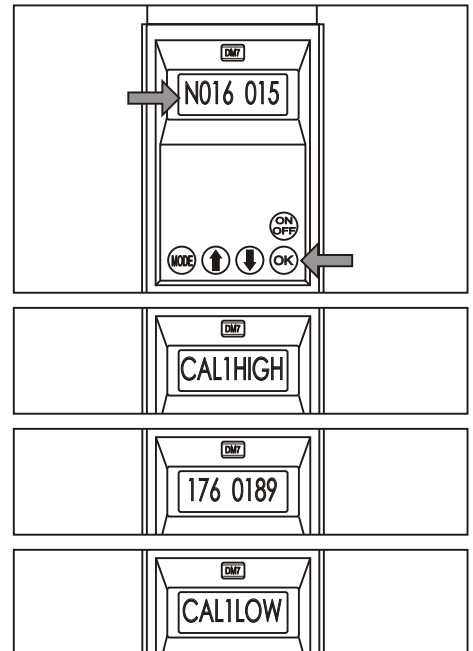
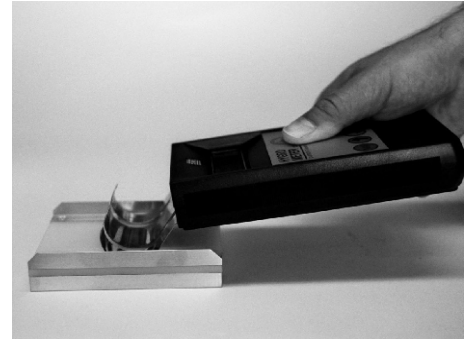

material group	test module	rated value
BD2 (A0)	PE05	$38 \pm 2\%$
BD2 (B0)	PE05	$10 \pm 1\%$
HD5 (H0)	PE30	$12 \pm 1\%$
PD2 (P0)	PE30	$8,5 \pm 0,5\%$

Special Usings, Recommendation

Measuring moisture in **caravans, trailers, mobile homes**

For these applications we produce instruments with shortened sensors as shown in the picture. With such sensors measurements can be made in edges without being influenced through the adjoined wall.

We recommend the material setting HD5(H) (code 31)

measurement:

1. make a reference measurement at a dry place
2. change the material setting until the instrument shows approx. 5%
3. now different similar places can be checked for higher moisture content.

Attention:

Frames may also cause higher moisture readings. Therefore the instrument can also be used to detect frames.

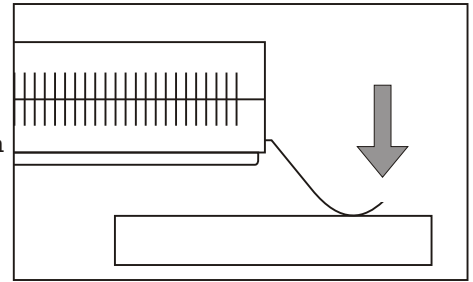

Moisture measurement in plastic boats:

Caused through Osmose plastic boats can get blisters below the water line. At this blisters the moisture in the plastic rises up. Before starting a repair such parts must be completely dry.

We recommend the material setting HD5(H) (code 31).

The surface of the place where you need to measure must be dry!

Measurement:

1. take a reference measurement above the water line
2. select the material no. until the reading is approx 10%
3. now you can measure at similar places to see the moisture differences.

Attention: Frames or moutings may also causes higher moisture readings. Therefore the moisture meter also can be used to detect frames or mountings at the opposite side of the wall.

Moisture Meter Type DM4A

Battery:

we recommend to use always high quality batteries, e.g. alkaline or lithium 9V block batteries.

If the battery is running low, the display shows "B" instead of the % in final position.

Change battery:

- open the battery box for example with a small screw driver
- take out the battery
- insert new battery, **observing the correct polarity !**

Attention!

In accordance with battery legislation, all used batteries must be disposed off in special battery collecting bins.

The disposal of old or used batteries as part of normal waste is not allowed!

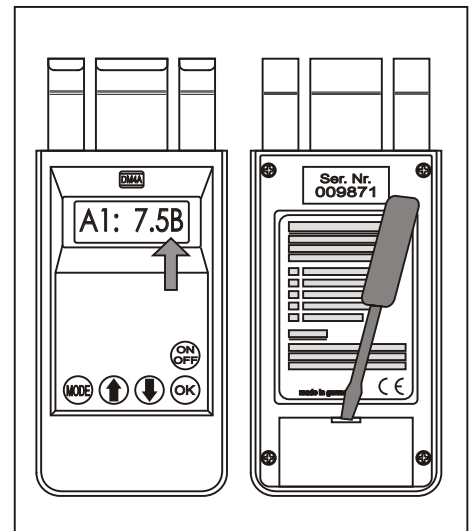

Optional Extras:

- test modules for checking and calibrating the moisture meter (state the type of the meter)
- plastic case for better protection
- different types of moisture meters
- special calibration of the moisture meter
- interface cable and PC software **DMI-Controller**

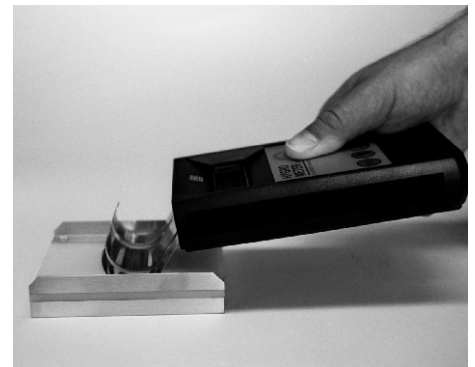

Our operating instructions are intended for guidance and to provide information on our products and their uses. They should not be taken to imply special characteristics or suitability for any specific purpose, other than those stated.

We constantly work to improve our products and reserve the right to alter our products and operating instructions without advanced notification.